



M&M Manufacturing Company

www.mmmfg.com

AUSTIN
(512)-960-2370

DALLAS
(972)-485-1504

FORT WORTH
(Adolph)
(817)-334-0034

FORT WORTH
(MKIV)
(817)-336-2311

HOUSTON
(713)-690-0585

LITTLE ROCK
(501)-888-3042

PROPRIETARY INFORMATION

THIS DRAWING AND/OR DATA SHEET, AND THE CONFIDENTIAL PROPRIETARY INFORMATION THEREON, ARE THE PROPERTY OF M&M MANUFACTURING, INC. AND ARE NOT TO BE REPRODUCED OR COPIED IN WHOLE OR IN PART, OR USED FOR UNAUTHORIZED MANUFACTURING OR ANY OTHER EXPLOITATION OF THE ITEM DISCLOSED THEREIN, OR IN ANY OTHER WAY DISCLOSED OR USED FOR FURNISHING INFORMATION.

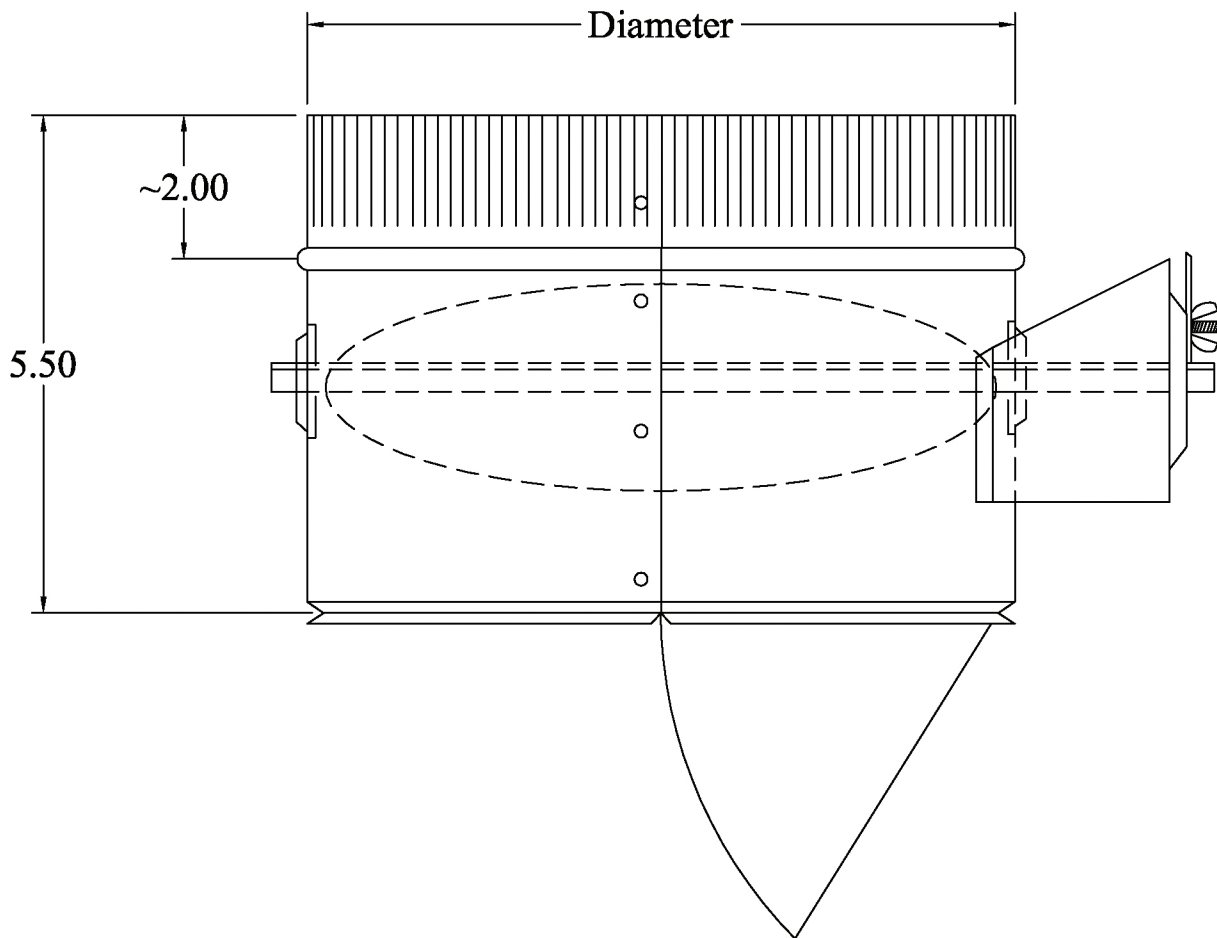
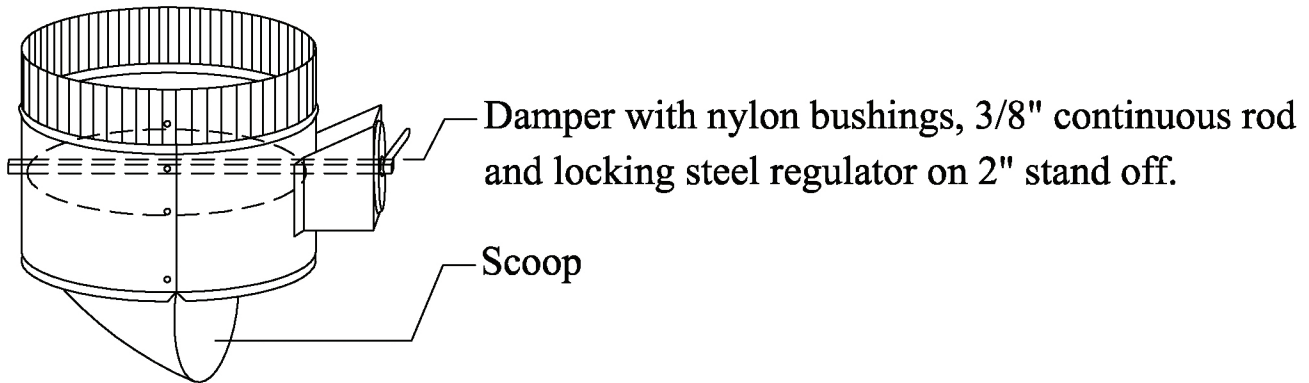

PART #: 504MSDX(Size)ELV382 | **DESCRIPTION:** Metal Spin In Starting Collar

NOTES: Material: 4" - 14" = 28 ga.; 16" - 18" = 26 ga.; 20" = 24 ga.

ASTM-A653 CS B galvanized steel

4" W.C. Positive Pressure Commercial SMACNA Gauge

Order as #504MSDX(diameter in inches)ELV382