



# M&M Manufacturing Company

[www.mmmfg.com](http://www.mmmfg.com)

AUSTIN  
(512)-960-2370

DALLAS  
(972)-485-1504

FORT WORTH  
(Adolph)  
(817)-334-0034

FORT WORTH  
(MKIV)  
(817)-336-2311

HOUSTON  
(713)-690-0585

LITTLE ROCK  
(501)-888-3042

**PROPRIETARY INFORMATION**

THIS DRAWING AND/OR DATA SHEET, AND THE CONFIDENTIAL PROPRIETARY INFORMATION THEREON, ARE THE PROPERTY OF M&M MANUFACTURING, INC. AND ARE NOT TO BE REPRODUCED OR COPIED IN WHOLE OR IN PART, OR USED FOR UNAUTHORIZED MANUFACTURING OR ANY OTHER EXPLOITATION OF THE ITEM DISCLOSED THEREIN, OR IN ANY OTHER WAY DISCLOSED OR USED FOR FURNISHING INFORMATION.

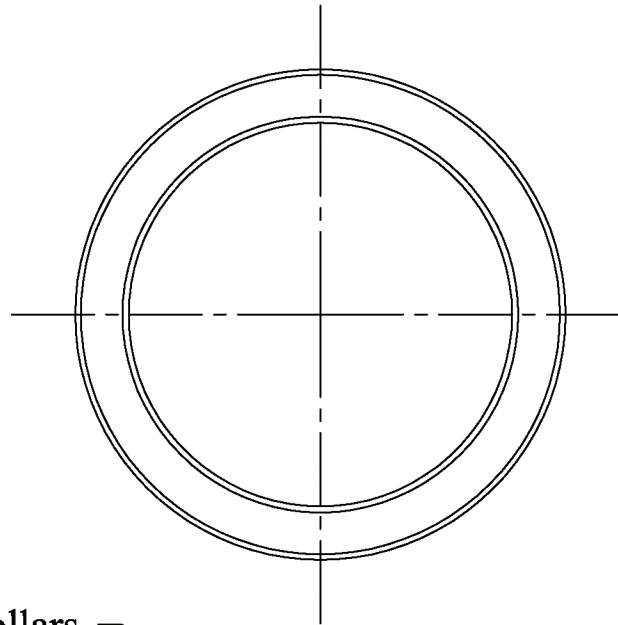

Hemmed Collars

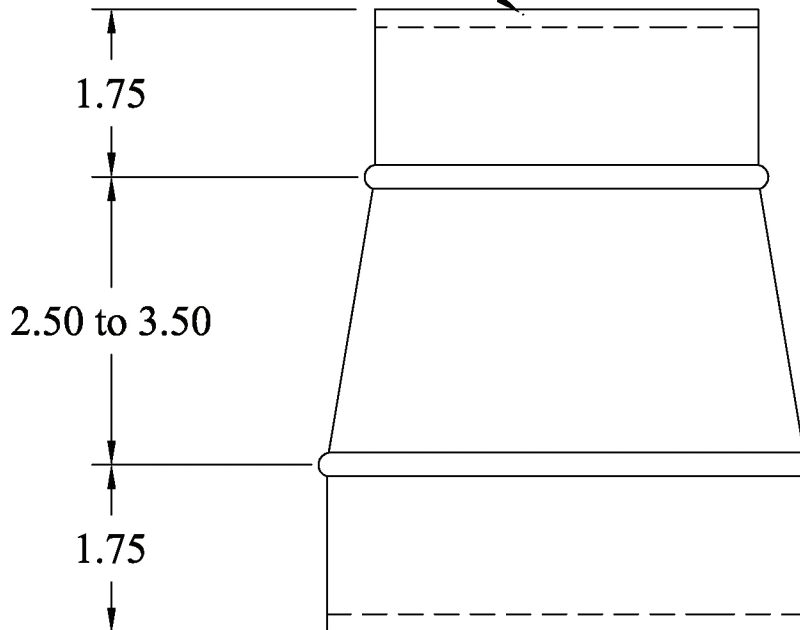

**PART #:** 400(Size) **DESCRIPTION:** ROUND REDUCER

**NOTES:** Material: 3" - 10" = 30 ga.; 12" - 18" = 28 ga.; 20" - 24" = 26 ga.

ASTM-A653 CS B galvanized steel

Larger diameter determines gauge

Order as Pt# 400(larger diameter)(smaller diameter)