



# M&M Manufacturing Company

[www.mmmfg.com](http://www.mmmfg.com)

FORT WORTH (MkIV)  
(817)-336-2311

FORT WORTH (Adolph)  
(817)-334-0034

DALLAS  
(972)-485-1504

HOUSTON  
(713)-690-0585

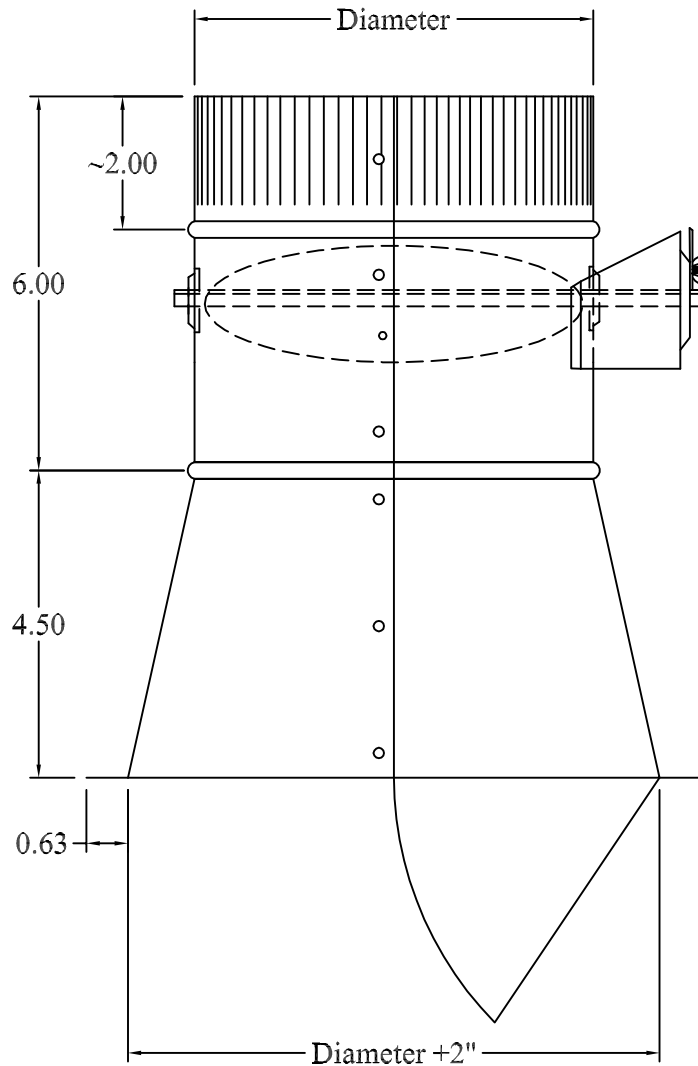
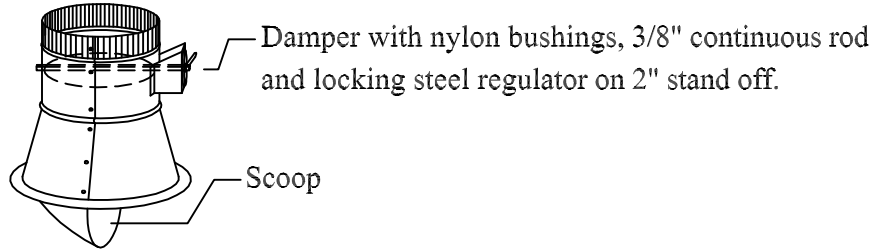

**PART #:** 505FDX(Size)ELV382

**DESCRIPTION:** Conical Flanged Starting Collar

**NOTES:** Material: 4" - 14" = 28 ga.; 16" - 18" = 26 ga.; 20" = 24 ga.

ASTM-A653 CS B galvanized steel

4" W.C. Positive Pressure Commercial SMACNA Gauge

Order as #505FDX(diameter in inches)ELV382